

**IMPAX™**

**1000**



# User's Guide

This manual is a comprehensive guide to the IMPAX 1000 Process Control System.

This User's Guide should be read and kept for reference by operators, managers, and supervisors responsible for the setup, operation, and repair of IMPAX monitoring systems. It is assumed that the software in the IMPAX 1000 is one of the releases of Versions 47 or 57. If your IMPAX 1000 has Version 48 or 58, you should refer to the User Guide for the IMPAX 2000.

If you are not sure not sure of the software version in your IMPAX 1000 unit please refer to chapter 8 of the Supervisor's Guide.

If you still have a question, problem, or an idea to make our system better, please let us know.

**IMPAX Systems are manufactured and distributed worldwide by:**

Process Technologies Group, Inc.  
30W106 Butterfield Road  
Warrenville, IL 60555  
Phone (630) 393-4777 Fax (630) 393-4680  
Web: [www.impaxptg.com](http://www.impaxptg.com) E-Mail: [impaxptg@aol.com](mailto:impaxptg@aol.com)

**“IMPAX” is designed and manufactured by Process Technologies Group, Inc. And is produced under the United States and Foreign Patent number 4,481,589. Any additional patents are pending or applied for. “IMPAX” is a trademark owned by Process Technologies Group, Inc. Copyright 1996.**

## Table of Contents

Chapter	Page
1. Introduction and Theory of Operation	1
2. Description of Controls	3
Control Console	4
3. Setup and Operation	5
Getting Started, Setting up new job	5
Clearing Counters	6
Clearing Tolerance/Errors	7
Starting a New Job	8
Tolerance Setup	9
Machine Operation	13
4. IMPAX Information Displays	14
Quantity Displays	14
Tolerance Displays	15
Error Displays	17
Force Displays	18
Backstroke/NoFeed Limits	21
5. Tolerance Setting Guide	22
6. Troubleshooting and Service	24
Problems - cause/remedy	24
Simple Repairs	25
Initial Installation	27
Customer Service	30
7. Specifications and Drawings	31
Specifications	31
Back view of Control Console	32
Satellite Circuit	33
IMPAX Control Console	34

## Chapter 1 - Introduction and Theory of Operation

### INTRODUCTION

IMPAX can assist the operator of a forming, threadrolling or metal stamping machine by counting parts produced, and monitoring stroke to stroke consistency. It is capable of stopping the machine instantly when the job is completed or when it detects a problem.

IMPAX prevents smashups, scrap production, and overruns, thus making the forming operation more productive and making the operator's job easier. Because it is merely a tool, it cannot replace skilled people, but it can help by reducing the drudgery of frequent inspections and repairs.

Operation of the machine is not changed by the addition of IMPAX. IMPAX is 'smart' enough to simply do its job, without interference or complication.

Although IMPAX operates mainly without attention, it does require the machine operator to push a button once in a while. To get the best results from the system, you should become familiar with its operation.

Operator attitude is very important when introducing and implementing IMPAX. Like any other tool, its effectiveness depends on how well it is used. If machine operators perceive it as unnecessary, complicated, an invasion of their routine, or a threat to their jobs, it will not work even if it is technically perfect. It is vital that everyone understand that IMPAX can make forming operations easier and more productive; that makes the whole company more competitive, which in turn makes everyone's job more secure.

### THEORY OF OPERATION

The IMPAX monitoring system measures and remembers the forming force generated in each forming station, for every machine stroke. The principle of operation is simply that when the forming process changes (due to tool breakage, material variation, machine problems, etc.) The forces required to form the part also change. IMPAX can be set up to detect a variety of changes and stop the machine before further damage or waste occurs.

The heart of this system is the force measurement. Attached behind each forming station is a piezoelectric force sensor. The piezoelectric element generates a voltage each time a part is

struck, twisted, deflected, etc. Another device, the machine position sensor, is turned on by a timing cam when it is time for the part to be formed, at that time, the IMPAX monitor measures the impulse from each force sensor. This measurement is converted to a number and stored in memory. (The number is relative; it is not calibrated in any engineering units.) After a number of new parts have been made, an average force level is determined and limits are set above and below this average. Because some jobs run better than others, these limits are adjustable. When the force of any stroke exceeds the limits, the process is stopped.

Stopping the machine is all the process monitor can do. It cannot fix the problem or restart the machine. When a problem is detected a red light turns on to attract your attention and an error message is displayed on the IMPAX unit's display. The machine is stopped, and any accessories are shut down in an orderly manner. A gate or diverter may also be used to trap the part which is suspected to have caused the shutdown error.

Obviously, this system does not directly measure the quality of the parts; it indirectly measures the consistency of the process. If a machine is running erratically or the raw material is inconsistent, this monitor will not perform as well. Remember that IMPAX will not remedy any problems with the manufacturing process, it can only detect them and shut the process down.

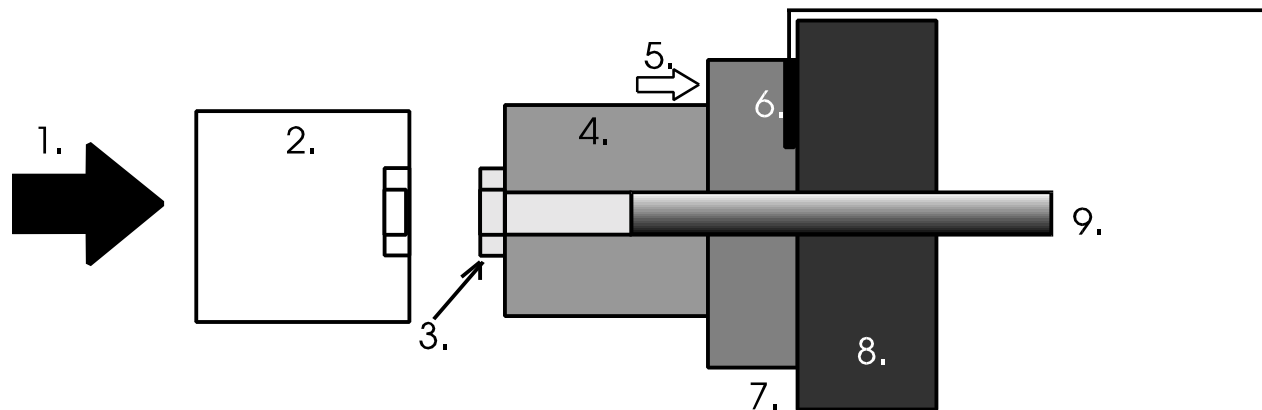

- |  |                                |
|--|--------------------------------|
| <b>1. Ram Motion</b>                                   | <b>6. Piezoelectric Sensor</b> |
| <b>2. Punch</b>  | <b>7. Backplate</b>            |
| <b>3. Finished Part</b>                                | <b>8. Machine Bed</b>          |
| <b>4. Die</b>  | <b>9. Kickout</b>              |
| <b>5. Transmitted Force that will reach the sensor</b> |                                |

## Chapter 2 - Description of Controls

The IMPAX monitor is comprised of several components which are interconnected by wiring. All components are mounted on the forming machine except for the **IMPAX Control Console** which is isolated on its own pedestal.

The **Control Console** is the core of the system, housing the microcomputer and power supply. Its front panel contains the **Message Display Panel** and the **Keypad**, through which you can receive information and enter commands. It also contains the **Locking Keyswitch** which accepts the **Supervisor's Key**. This key allows the supervisor or operator to 'program' IMPAX.

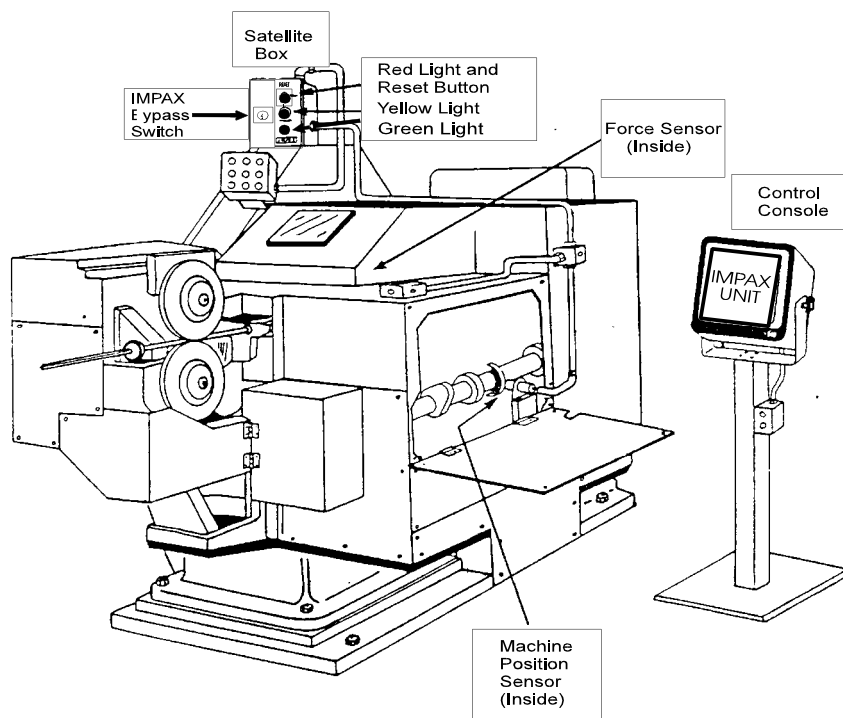

The **Satellite Box** is the junction for all the controls and components on the machine. The **Reset Button** is the only operator control. The red, yellow, and green **Status Lights** indicate the mode of operation that the IMPAX unit is in. The **Bypass Key Switch**, operated by the **Supervisor's Key**, disables the relay which stops the machine and its accessories, but has no other effect on operation. Note: There is no machine protection when the

IMPAX monitor is in Bypass mode.

Up to two **Machine Position Sensors** are used to sense the machine cycle and synchronize the stop signal. **Piezoelectric Sensors** are installed in stressed locations near the forming stations; on the back of the die-bolster or backing plate, on knockout rockers, in punch wedges, etc. A recess is cut (about the size of a quarter), or a hole is drilled, and the sensor is installed using a special epoxy adhesive. When the machine is reassembled, the sensors are out of sight, but sensitive to the forming process.

Relays within the **Satellite Box** are also wired to the **Machine Stop Circuit** (if available), as well as to the feed stop and other accessories, as required to stop the machine and the process. The **Control Console** interfaces with the **Satellite Box** via a multi-conductor cable.

## CONTROL CONSOLE

The IMPAX Control Console contains a message display panel, a data entry keyboard, and a locking keyswitch. The display panel shows information which is requested, or supplies prompts or questions during operation. The **Keypad\*** is used to enter commands or information, and the keyswitch enables authorized users to program the unit. The function buttons may operate differently depending on the position of the key switch. If the key is removed, IMPAX will only display information. If the key is inserted, the **Keypad** can be used for programming and diagnostics.

There are three kinds of buttons on the keypad. *Functions* buttons let you command IMPAX to display or change things, *Control* buttons are used to enter commands and *Data* buttons let you enter in numbers and codes.

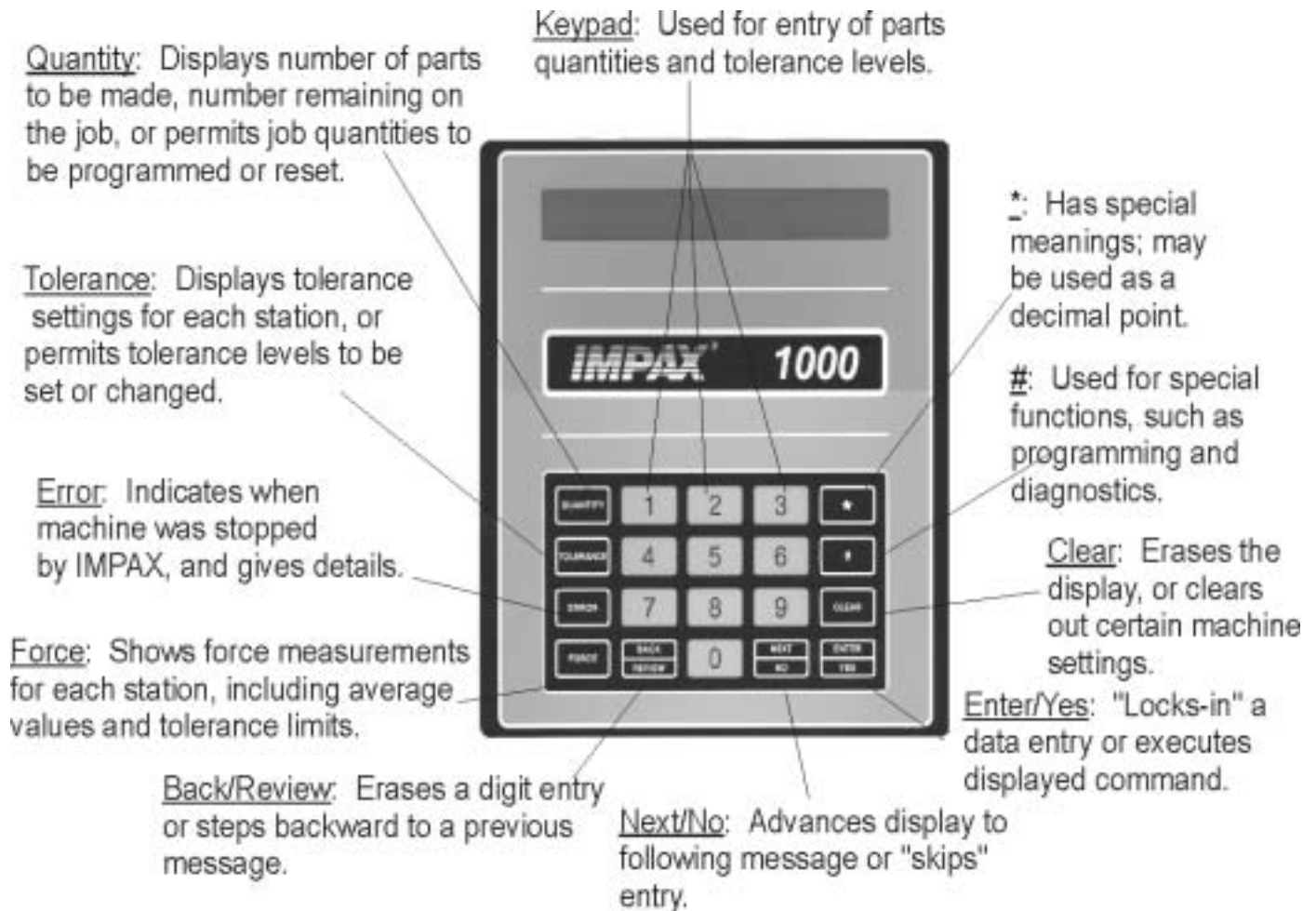

\*Additional Keypad Reference on Page 34

## Chapter 3 - Setup and Operation

### *Getting Started*

To “Program” the IMPAX Controller, you must supply several basic types of information:

1. *The total number of parts to be made on work order. (Up to 99,999,999)*
2. *The number of parts to be made prior to a predetermined inspection or tool change (this feature may be omitted).*
3. *The force variation tolerance settings (scale of 1 to 9, automatic tolerance, or no tolerance) for each forming process.*
4. *A “trend limit” which limits how much the force values can change as the machine heats up or tools wear down (this feature may be omitted).*
5. *The desired number of exceptions, which let-by a small percentage of “bad” parts (this feature may also be omitted).*

Setting up the IMPAX unit for a new job may be done any time before beginning the job, by anyone who has a **Supervisor’s Key**

### *Clearing the old job*

Before setting up a new job you must Clear the existing functions which do not apply to the new setup. When the old job is finished, insert the Supervisor’s Key and turn it to the right so it is in a horizontal position.

Insert Key and turn to the right from the  
Vertical position to the Horizontal position

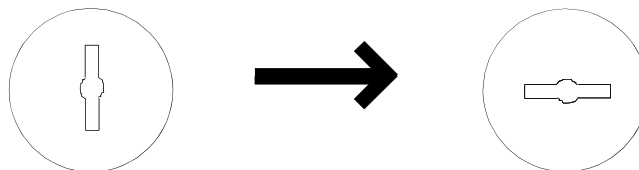



## Clearing Shift, Break, and Production Counters:

Press Clear . The display will show “SELECT TO CLEAR”. This display means that the IMPAX unit wants to know what to erase.

### Press

### Display Will Show

Clear

SELECT TO CLEAR

Quantity

CLEAR SHIFT?

#### **IF YOUR ANSWER IS YES:**

Enter/Yes

SHIFT CLEARED

CLEAR BREAK?

#### **IF YOUR ANSWER IS NO:**

Next/No

CLEAR BREAK?

#### **IF YOUR ANSWER IS YES:**

Enter/Yes

BREAK CLEARED

CLEAR PROD?

#### **IF YOUR ANSWER IS NO:**

Next/No

CLEAR PROD?

#### **IF YOUR ANSWER IS YES:**

Enter/Yes

PROD CLEARED

CLEAR EXPTS?

#### **IF YOUR ANSWER IS NO:**

Next/No

EXPTS CLEARED?

Press Quantity . The display shows “CLEAR SHIFT?” The IMPAX unit is now asking whether or not you want to erase the total number of parts made during the shift. If not press Next/No. (You may want to record this number before erasing; to do so, see Chapter 4, Information Displays.) If you wish to erase this press Enter/Yes.

Now the shift total is erased and the display shows “CLEAR BREAK?” The IMPAX unit is now asking whether or not you want to reset the counter which makes the periodic stops for tooling changes or inspection. If you do not wish to do this, press Next/No. If you desire to, press Enter/Yes.

Now the break counter is reset and the display shows “CLEAR PROD?” The IMPAX unit is now asking whether or not you want to completely erase the record of that preset production count. This clears the total of parts made, as well as the break counter. If you do not wish to do this, press Next/No. If you desire to, press Enter/Yes.

IF YOU HAVE AN IMPAX 2000, the display will show “CLEAR EXCEPTIONS”. If you wish to clear this counter press Enter/Yes. If you do not, press Next/No, and the display will return to the default message display.

# Clearing The Tolerance and the Error Record:

The IMPAX monitor production counters are now cleared. It is ready to be set up for a new set of quantities. In fact, it will not run (except in TEST mode) until a new production quantity is entered.

The Tolerance and the Error records can be cleared by pressing Clear until the "SELECT TO CLEAR" screen appears and then pressing the respective button on the **Keypad**. Remember these steps can be avoided without harm to the unit or the data for the next job.

The IMPAX monitor is now cleared and is ready to be set up for a new job. In fact, it will not run (except for short setup runs) until new production quantities and tolerance values have been re-entered.

The display will show "CLEAR EXCEPTIONS?". Press Enter/Yes to clear the record of the Exceptions.

## Press

## Display Will Show

### *TOLERANCE:*

Clear	SELECT TO CLEAR
Tolerance	CLEAR TOLERANCE?
Enter/Yes	TOLERANCE CLEARED

### *ERROR:*

Clear	SELECT TO CLEAR
Error	CLEAR ERRORS?
Enter/Yes	ERRORS CLEARED

*In the IMPAX 2000, the display will now show:*

	CLEAR EXCPT?
Enter/Yes	EXCPT CLEARED

# Entering the Quantities Needed To Start a New Job:

Insert the **Supervisor's Key** and turn it to the right. Press the **Quantity** button and the display will show "ENTER QUANTITY", which asks you to type in the total number of pieces to be made on this job.

Insert Key and turn to the right

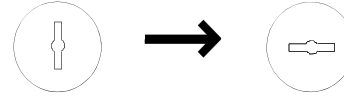

Press the number buttons to show the quantity you want to produce. If you make a mistake, use the **Back/Review** button to change the number. Check the display to be sure you have typed in the correct number. Press the **Enter/Yes** button to enter the quantity.

Press                      Display Will Show

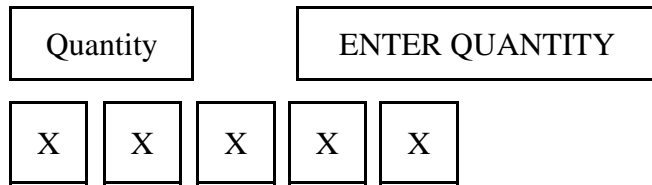

(up to 99,999,999)

The display will now ask for the "BREAK QUANTITY" which is the number of pieces to make before stopping for inspection or tool change. (This reminds you of periodic adjustments, inspections, maintenance, etc. that are based on machine or production cycles). Press the number buttons to show the quantity you wish to make without interruption. Use the **Back/Review** button if you make a mistake. If you do not want any interruptions due to the *Break Quantity* counter, press the **Q** button and the IMPAX unit will skip this. When you have typed in the correct *Break Quantity*, press the **Enter/Yes** button.

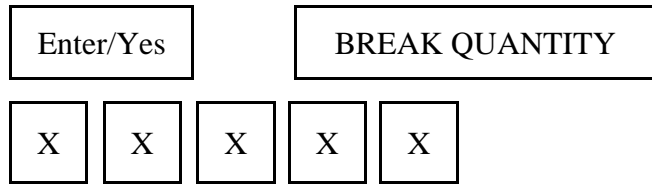

(up to 99,999,999)

*If the tolerances are set and you are done:*

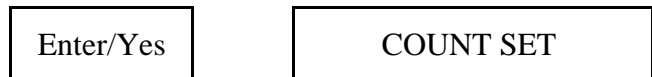

*If the tolerances need to be set :*



If tolerance values have already been entered into the IMPAX system, the unit is ready to begin monitoring and the display will read "COUNTS SET."

If any tolerances need to be set, IMPAX reminds you to continue by displaying "CHANNEL 1 ?" If "COUNTS SET" appears, you have completed the basic program set up.

*Note: There is a way to change the piece counts after the job has begun, or to begin a job with the counters set to some number other than zero.*

## Setting Tolerances:

You will be asked to give a tolerance number to each measuring channel. This value controls how closely that station is to be monitored. (Refer to page 23 of this guide)

The display now shows “CHANNEL 1 ?”, asking for a tolerance number for the first station. Press a number from 1 to 9, 0, “\*”, or “#”. (Remember that low numbers give tight control and higher numbers permit more variation; zero means that the station has no tolerance limits applied at all. “\*” sets the tolerance automatically). If fixed limits are enabled in channel definition (see Programming section of Supervisor’s Guide for this procedure) then you can press the # key to switch between fixed and normal limits. These limits are usually only used when the tolerance needs to be tighter than a “9” will give or looser than a “1” will give without being zero.

If you enable this the screen by pressing #, it will show “C1 LOW LIM 0”. It is asking you what you want the lower limit to be. Enter the lower limit and press Enter. The next screen will say “C1 HIGH LIM 0”. The monitor is now asking for the upper limit of tolerance. Enter the value and press Enter. If you go to the Force screen, you will see the limits you just entered.

For ideas on setting Normal tolerances, see Section 5, Tolerance setting guide. When you have entered the number, press Enter/Yes.

The following options will only be available if they are enabled in the channel definition part of programming.

Press                      Display Will Show

CHANNEL 1 ?

*Z can be from 0 to 9, \*, or #.*

Z

CHANNEL 1 Z

**NOTE:** *If Fixed limits are enabled in Programming, then press:*

#

*to toggle between normal and fixed.*

### **IF FIXED LIMITS CHOSEN:**

X

C1 LOW LIM 0

*X can be from 0 to 253 in both low and high limits.*

Enter/Yes

C1 HIGH LIM 0

X

*Display might show “ALL FACTORS SET” or it might go on.*

### **IF NORMAL LIMITS CHOSEN:**

*Z can be from 0 to 9, \*, or #.*

Z

CHANNEL 1 Z

*(Same as if fixed limits not enabled)*

## Setting Tolerances - cont.

### ***Trend Setting***

After the Tolerance has been set for the first channel, press the Enter/Yes key. If Trending is turned on in Channel Definition, the next display will show "C1 TREND 0%". By entering a number here from 1 to 99, you can limit the amount that the force measurement can drift due to gradual changes such as tool wear. For example, pressing 50 displays "C1 TREND 50%", which will stop the machine after the force changes (gradually) by 50%; you would then clean or replace the tool. Set the Trend Factor by pressing the Enter/Yes key.

#### Press

Enter/Yes

#### Display Will Show

C1 TREND 0%

*(Trend can be set from 1% to 99%)*

*For Example:*

5

C1 TREND 50%

These options will only be available if turned on in Channel Definition in programming.

### ***Exception Setting***

If Exceptions are turned on in Channel Definition, the next display will show either "C1 CUMU EX 0" or "C1 CONS EX 0." An exception is an IMPAX detected error which you can allow the monitor to ignore. This feature is extremely useful if you have a diverter installed on the machine. If a diverter is installed, you can set one of the relays to be an exception relay and it will trip the diverter and divert the part without stopping the machine.

"CUMU" stands for cumulative. This means that IMPAX will allow a certain number of errors out of 100 to be ignored. For example, if I set the number to 2, IMPAX would allow 2 parts out of 100 to exceed either the HI or the LO limit without shutting down the machine.

"CONS" stands for consecutive. This means that IMPAX will allow a certain number of errors in a row to be ignored.

**To permit exceptions, backstrokes, and/or low force readings: (All described below)**

X

*X can be from 1 to 9,999*

Enter/Yes

(Next option or channel)

**To not permit exceptions, backstrokes, and/or low force readings:**

Next/No

(Next option or channel)

*or*

Enter/Yes

(Next option or channel)

**Once all tolerances, fixed limits, excpts, nofeeds, and trend information is set:**

ALL FACTORS SET

## Setting Tolerances - cont.

For example, if I set the number to 2, IMPAX would allow 2 errors in a row but the 3rd error in a row would cause the machine to stop. When tuning the IMPAX unit, it is often helpful to set a large number of exceptions, say 10 or 15 and watch the force values in the Error/Exceptions buffer. This can tell you what the values were for the exceptions and can give you information needed to establish the proper settings for the tolerances.

### ***Backstroke Exception Settings***

Backstroke is only used for threadrolling applications. It is used to detect a part not being properly ejected and remaining in the dies. It is always a high force error. If Backstroke Hi Limit and Backstroke Exceptions are turned ON in Channel Definition, the display will show "R1 BKSTR 00/100". This function is always cumulative. You may put in a number between 1 and 99. Backstroke exceptions are rarely ever allowed but can be when there are problems with a threadroller which causes nuisance shutdowns in the backstroke cycle, if all other causes for backstroke noise have been eliminated.

### ***No Feed Settings***

No Feeds are cycles of the machines where no material is fed to the machine for processing. Usually No Feeds are used with piece-fed machines like threadrollers, but under special circumstances can be used with continuous or bar stock fed headers or other such applications. No Feeds can be either Consecutive or Cumulative. If this feature is turned on in Channel Definition, the display will show "R1 CONS NF 0000" or "R1 CUMU NF 0000." You can enter a number between 1 and 9999. In a threadrolling application, this feature is extremely functional since it will allow the machine to keep running even though the feed rail is not completely full or does not feed a part every time

### ***No Feed Exceptions***

No Feed Exceptions is a special feature which will divert a certain number of parts immediately after a No Feed condition. This may be used if, for example, there were several consecutive no feeds and the dies cooled off. The first ten parts may not be as good quality as those produced after the dies heated up. No Feed Exceptions could be set to eject these parts if they did not meet the tolerance parameters. If this feature is activated in Channel Definition, the display will show "R1 NOFEED EXCP." You cannot enter anything on this display, it is just informing you that No Feed Exceptions has been turned on. The next display is "\* 000 AFTER 000." The number entered here (0-999) is the number of "Fixed" cycles (when the Feed resumes) that the Special Exceptions will be allowed. Enter a zero, 0, if you want the number of special exceptions to be based on the amount of time the machine runs without feed. When the asterisk is in front of the leftmost number, it means you can change that number. After you enter a number, press the Enter/Yes key and the asterisk will move to in front of the rightmost number.

The number entered here (0-999) is the number of consecutive nofeeds which must be detected before the Special Exceptions (for 15 cycles, in this case) will be allowed. Press Enter/Yes after entering your number.

## Setting Tolerances - cont.

12

The next display will be "PLUS 1/ 0000." The number entered here (0-9999) will allow a Special Exception for 1 machine cycle per each group of x cycles the machine runs without feed. Example: If the number programmed here is 100, and the machine runs 600 cycles without feed, the forces will be allowed outside normal limits during the first 6 machine cycles during which the feed is again detected.

Enter the proper number and press the Enter/Yes key. The next display will show "ALL FACTORS SET."

## MACHINE OPERATION

Machine operation is not changed by IMPAX except that it may be stopped automatically when a problem occurs or a certain parts count is reached. The only additional controls are the Bypass Keyswitch, one Push-button, and three lights: red, yellow, and green.

The IMPAX unit has four modes of operation: STOP, TEST(set up), LEARN, and PRODUCTION. These modes are indicated on the **Satellite Box** with three colored lights.

STOP mode is indicated by a red light only. When the IMPAX unit is turned on, it comes up in STOP mode. STOP mode will prevent the machine from running. If the machine is running and the IMPAX is switched to STOP mode, the machine will stop and in most cases the material or parts feed will be interrupted.

TEST (set up) mode is indicated by a yellow light only. Pressing the reset button (which is incorporated into the red light) switches the IMPAX from STOP to TEST mode. TEST mode will allow the machine to run, but IMPAX does not increment the parts counter or process force information during this time. There is no machine or tooling protection. Because there is no protection in TEST mode, a TEST LIMIT (T LIM) quantity is built in as a fail-safe. If the machine is left running past the test limit quantity, IMPAX stops the machine (red light) and displays T LIM. Normally the test limit is set to 100 parts.

LEARN mode is indicated by the yellow and green lights lit together. Pressing the reset button switches the IMPAX from TEST to LEARN. This should only be done when the machine is at production speed and producing good parts. During the initial LEARN following set-up, the IMPAX learns the parts that the machine is producing, assigns a numerical value to the force signal, establishes how much change or variation occurs during normal forming, and makes this information available to you. This information is retained in memory for subsequent restarts. Initial LEARN takes approximately 150 parts.

Upon completion of LEARN, the yellow light goes out but the green light stays on. This indicates the IMPAX is in PRODUCTION mode, and it is watching forces for levels outside the limits established by the tolerance settings. If you wish to return to the yellow (setup) mode when the green light is on, press the Reset button again. The green light will turn off, and the yellow light will turn on.

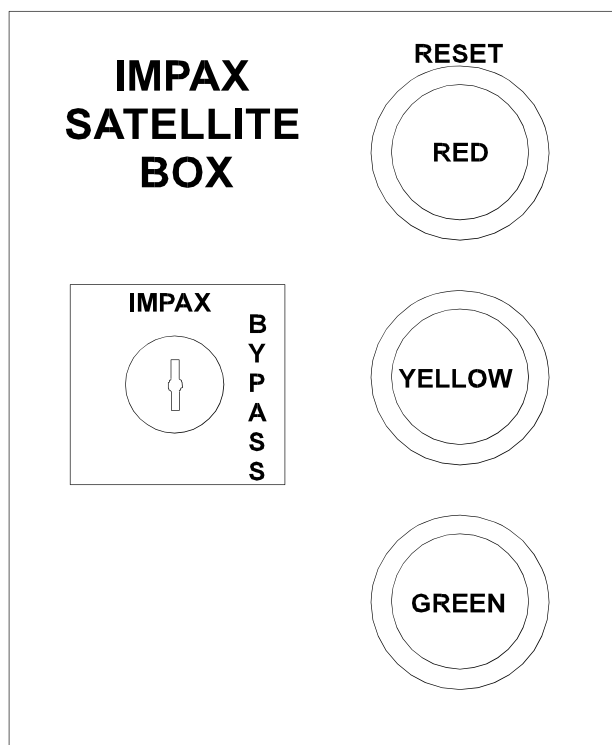



## Chapter 4 - IMPAX Information Displays

Useful information is available from the IMPAX console simply by pressing buttons. This may be done whether the machine is running or stopped. Unless otherwise instructed, the **Supervisor's Key** should be removed or turned to the vertical position while performing these steps.

To inquire about Quantity settings or production totals, Tolerance settings, Error conditions which have occurred, or Force measurements and limits, press the appropriate button.

### Quantity displays:

(Numbers are for example only)

Press Quantity. The display will show "MADE \* 750" if 750 parts have been produced on this job. If the machine is running and the green light is on, the number will be counting up.

#### Press

Quantity

#### Display Will Show

MADE \* 750

Press Next/No again and the display changes to "TO GO \* 99250", which is the number of parts remaining to be made. This number counts down when the machine is running.

Next/No

TO GO \* 99250

Press Next/No again and the display changes to "SHIFT \* 750", which means that 750 parts have been made during the current shift.

Next/No

SHIFT \* 750

Press Next/No again and IMPAX shows "B MADE \* 750", which means that 750 parts have been made during the current shift.

Next/No

B MADE \* 750

Press Next/No again and the display becomes "B TO GO \* 4250", meaning that 4250 more pieces will be made before the machine is stopped for an inspection break. This also counts down.

Next/No

B TO GO \* 4250

Press Next/No again and the display shows "TOTAL \* 100000", which tells the total number of parts to be made on

Next/No

TOTAL \* 100000

## Quantity Displays - cont.

that job. (Note that MADE plus TO GO adds up to the parts TOTAL.)

Press Next/No again and the display shows “BREAK \* 5000”, which means that the BREAK counter is set up to stop after every 5000 parts.

Pressing Next/No again brings the display back to “MADE \* 750”, which brings up the first display again; continuing to press Next/No takes you through all the choices again. At any time, pressing Back moves backward to the previous choice in the order listed above. You may select which counter you wish to be displayed while the machine is running. To do so, display the chosen counter as explained above, then press Enter/Yes. The selected counter will remain visible.

## Tolerance displays:

(numbers are for example only):  
Be sure the Supervisor’s Key is removed or turned off (vertical).

Press Tolerance. The display will show the tolerance setting for the first channel. For instance, if it reads: “CHANNEL 1 5(?)”, then the tolerance setting for channel 1 is set to 5.

--You will know which tool the IMPAX unit is referring to by the display: ex. “STATION 1” or “BLOW 1”.

--The number in parenthesis is the variance IMPAX is detecting in the forming process, also on a scale of 1 to 9. The tolerance can be set lower or higher than the variance. When there is a (?) in the variance, it means that IMPAX is still calculating the variance.

Press

Display Will Show

Next/No

BREAK \* 5000

Next/No

MADE \* 750

**To display chosen counter:  
Keep pressing**

Next/No

**until chosen counter appears.**

Enter/Yes

**Make sure the Supervisor’s  
Key is turned off**

(to the  
left)

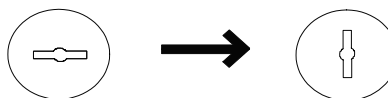

Tolerance

CHANNEL Y X(?)

*X is the tolerance setting for channel Y  
X can be from 0 to 9, or \**

## Tolerance Displays - cont.

--If the tolerance is set for automatic, the “\*” will appear after the channel number and it may be accompanied by a (number) which indicated the equivalent tolerance level or a (?) Which means no tolerance has been computed yet.

--An “N” means that no tolerance has been set; the setup is not complete and the job may not be started.

Press Next/No. The display will show the next channel, for instance, “STATION 2 8(6)”, which would mean that channel 2 is set for tolerance level 8 but the current variation in the forming process is equal to 6.

Press Next/No again, and the next channel will be displayed. This may be repeated until all the desired channels have been displayed.

Press Back at any time to return to the previous display.

If you wish to change a tolerance setting you must insert the **Supervisor’s Key** and proceed as instructed in Chapter 5, **Tolerance Setting Guide**.

### Press

### Display Will Show

Next/No

CHANNEL Y X(?)

*X is the tolerance setting for channel Y  
X can be from 0 to 9, or \*.*

Next/No

*until all channels have been displayed*

## Error Displays - cont.

(messages are for example only):

Press Error. If there have been no problems since the job began (or since the Error display was last cleared,) the display will show “NO ERROR”. If an error is recorded on a multi-station header, the display might show “CHANNEL 3 ERROR”. This would mean that the problem was detected on the station connected to channel 3. On a threadroller the display might show “BACKSTR ERROR”, meaning a problem on the backstroke.

Press Next/No. The display will show “ERROR 750”. This means that the most recent error stopped the machine when the 750th part was made.

Press Next/No. The display will show “FORCE TOO HIGH or “FORCE TOO LOW”, indicating which of the control limits was breached.

Press Next/No. The display will now show “SINGLE HIT”. This means that the force change was severe enough to warrant stopping after just one hit. It may instead show “LO COUNT”, “MED COUNT”, or “HI COUNT”; these indicate a gradual change in the process and tell how many parts were run before the force difference became severe enough to stop. HI COUNT means a small change in force was detected over an average of many blows. Generally, a single blow fault is due to a smashup, double feed, or other sudden, severe problem. An error detected over a larger number of blows is often due to a chipped tool, hard material, or other small change.

Press

Display Will Show

*If there have been no errors since the display was last cleared or the job began.*

Error

NO ERROR

*If there has been an error on Channel X*

CHANNEL X ERROR

Next/No

ERROR XXX

*XXX is the number of the part where the most recent error occurred.*

Next/No

FORCE TOO HIGH

FORCE TOO LOW

Next/No

SINGLE HIT

or

LO COUNT

or

MED COUNT

or

HI COUNT

## Force Displays:

In certain cases, the above two messages may be replaced by a special message. "PEAK SATURATION" would mean that the force input was higher than IMPAX could measure; an electronics adjustment may be required. "TREND ERROR" means that the force changed very slowly and reached a previously set trend limit. This is usually caused by tool wear or some other slow change. "NOFEED ERROR" means that too many strokes have occurred without any forming force being measured. "BKSTR HI LIM" means that an excessive force was measured on the backstroke of the ram or slide.

Press Next/No. The display now shows numbers, such as "101\*157\*150 6(3)". This shows the force measurement which caused the IMPAX to stop the machine. Note that the middle number must always be either above the upper limit or below the lower limit for an error to occur in force. In this case it is above the upper limit. The number 6 is the current tolerance setting. The 3 is the variance IMPAX is detecting in the forming process.

Press Next/No. The display will show "CHANNEL 1 ERROR". This is information about the fault which occurred before the error at 750 (described above). Continuing to press Next/No will display the faults which have been recorded in reverse order. At any time, you may press Back to return to the beginning of that Error message. Pressing Back again steps backward to the beginning of the previous Error message. Pressing Clear returns the display to the selected (default) screen. After the last Error is displayed, pressing Next/No will display "END OF ERRORS." Refer to page 10 to clear errors.

### Press

### Display Will Show

PEAK SATURATION

*or*

TREND ERROR

*or*

NOFEED ERROR

*or*

BKSTR HI LIM

*numbers are for example only*

Next/No

101\*157\*150 6(3)

Next/No

CHANNEL 1 ERROR

Next/No

(All other errors in reverse order)

Next/No

END OF ERRORS

(default screen)

*At any time during errors:*

Clear

(default screen)

## Force Displays:

(numbers are for example only):

Press Force. The display will show “C1 098\*120\*142” which means that the force measurement for channel 1 is 120 and the machine will be stopped if that number falls to 98 or goes up to 142. (Remember that the numbers are relative; they do not represent pounds or tons). The middle number may change with every stroke; the other numbers will change most when IMPAX first ‘learns.’ These numbers are devised by IMPAX based on the average force value and the tolerance number entered for that channel.

### Press

### Display Will Show

Force

C1 098\*120\*142

Press Next/No. The display will now show “C2 105\*125\*150” which is the force measurement for the next channel, channel 2. Pressing Next always advances the display to the next channel; pressing Back returns to the previous channel.

Next/No

C2 105\*125\*150

Next/No

(All other channels)

Press 1. The display for the channel being shown will change to “C2L 110\*124\*140”. The first digit shows that it is still channel 2, and the force measurement (middle number) remains approximately the same. The “L” means that the measurement now shown is a “Low Count” sample, which is the average of a few successive blows. Note that the middle number does not change as often or as greatly as before. Therefore the upper and lower limits can be closer.

1

CXL 110\*124\*140

*where X was the channel being displayed*

Press 2. The display will change again to “C2M 115\*125\*135”. This is the “Medium Count” sample for channel 2 (shown by “C2M”) which is an average of sixteen (16) blows. The limits are closer yet, and the middle number changes even less than before.

2

CXM 115\*125\*135

*where X was the channel being displayed*

## Force Displays - cont.

Press 3. The display will now show “C2H 118\*125\*132”. This is the “High Count” sample for Channel 2 (“C2H”) and it is an average of sixty four (64) measurements. The middle number is very steady so the limits can be very close to it.

Press

Display Will Show

3

C2H 118\*125\*132

Press 4. The display will show “C2T 065\*125\*185”. This is the “Trend” display for channel 2 (“C2T”) and it shows how far the force can slowly change before it is stopped.

4

C2T 065\*125\*185

If any of these limits have been disabled by special programming, the display will show the measurement without any limits, for instance: “C1H \*125\*”.

*If*

*any of these limits have been disabled, no limits will be shown, only the measurement:*

C1H \*125\*

Press 9. The display will show “C1 M 120\*128\*136”. The upper and lower limits show the highest high and the lowest low in the last 64 strokes. This is used to determine the correct tolerance setting.

9

C1 M 120\*128\*136

Each of these measurement levels is sensitive to certain kinds of problems. The single blow limits can catch a smashup in one stroke, but may not be sensitive enough to notice a tool chip because the force measurement varies too much. The High Count limits will not stop a smashup quickly enough, but may notice a small chip and stop the machine after a few dozen have been made. The Trend program can catch tool wear and other gradual changes. Remember that all of these limits are working all the time; the force display only controls which one is being displayed at that moment.

Another useful force function is the \*. Typically IMPAX multiplies the force measurements by a scale factor. If you wish to see the actual measurements instead of the scaled numbers, press the \* button while looking at the force display. The display will change to show actual sensor measurements, on the scale from 0 to 65000. This is useful for comparing force displays to error messages, which always show unscaled, actual measurements. To change the display back to scaled numbers, press the \* button again.

Note for roll-forming controllers: IMPAX controllers applied to rolling machine monitor forces exactly as described above, except that there are only two channels, one for the forward rolling stroke and one for the backstroke. Since no part should roll back through the die, there is never a minimum limit on backstroke force.

## Backstroke and Nofeed Limits:

To see the **Backstroke limit**, press Force then 9 (Minimum/Maximum settings), then 9 again. This will display “018\*128\*002”. The first number, 018, is the **Backstroke High Limit**, the middle number, 128, is the **Force**, and the last number, 002, is the **Current Backstroke Force**.

If you press 9 again and Nofeeds are turned on in Channel Definition, then this display will show: “C2 N 043\*128\*045”. The first number is the NoFeed Threshold. This can be used to check if Nofeeds are working correctly. Just stop the feed and the **Average Force Value** should go below the 043 **Nofeed limit**. The middle number is once again the force and the last number does not mean anything.

Note: For backstroke and nofeeds to display, these features must be turned on in Channel Definition.

### Press

### Display Will Show

*(only for threadrolling applications)*

*(numbers are for example only)*

Force

C2 105\*125\*150

9

C2 M 120\*128\*136

9

C2 B 018\*128\*002

**018: Backstroke High Limit**

**128: Force**

**002: Current Backstroke Force**

9

C2 N 043\*128\*045

**043: NoFeed Threshold**

**128: Force**

**045: (meaningless)**



## Chapter 5 - Tolerance Setting Guide

### IMPAX

tolerance limits are adjustable because every forming job is different. If a machine is running well and making high quality, consistent parts, a low tolerance number can be used. If the job is sloppy, or the material is inconsistent, or the quality of the part is not critical, a higher number may be chosen. Tolerance selection is a compromise; there are several factors to consider. The best compromise is a tolerance setting which is slightly wider than the normal force variation; unnecessary stopping is minimized, but all real problems will be caught.

Consistency is important. IMPAX works best when the forming forces are unchanging. Sometimes this may be improved by careful setup, tight tooling, and uniform material. This also improves the quality of the finished part, which is an objective of any good manufacturing operation.

Unnecessary Stops must be prevented. If the tolerance is set too tightly, productivity may actually go down. When IMPAX stops a machine frequently for no reason, the tolerance setting is too low (or the job is too sloppy; see paragraph above). When IMPAX catches every problem but seldom stops when nothing is wrong, the tolerance is set properly.

### MANUAL TOLERANCE

To set the tolerance on a new job, begin with a fairly high number such as 7, 8, or 9. Watch the job and, if it runs well, set the tolerance lower after each few thousand parts are made. Look at the force display to see how close the limits have been set. When the IMPAX begins to stop the machine and no problem is found, 'back off' by raising the tolerance setting. Check the force display occasionally to be sure the force limits are as close as they can be; adjust the tolerance as needed. Also, check the tolerance display; it may indicate that a different tolerance setting may be used. (The current variation may change slightly over a time.) These adjustments should be made slowly, over a period of time.

### AUTOMATIC TOLERANCE

This option may also be used to learn the settings for a new job. This is helpful if you are busy, or if the machine has many stations. To use Auto-Tolerance, enter a \_ instead of a number when setting up the tolerances for the job (see Chapter 3). IMPAX will automatically adjust the limits on that station. The tolerance information display will then show the equivalent tolerance which has been set, for instance; "CHANNEL 1 \*(5)" would mean that, for Channel 1, Auto-Tolerance has set a tolerance level equal to 5 on the scale from 1 to 9.

One problem with Auto-Tolerance is that if the forming process becomes inconsistent very gradually, IMPAX may 'track it' and not catch the problem. You should set the tolerances manually after the job is running well; the Auto-Tolerance numbers may be used as a guide.

Remember that the worst mistake is setting too loose a tolerance (high numbers) or no tolerance at all (zero). IMPAX will count parts, but it will not catch important process changes.

The **Supervisor's Key** is needed to set or change the tolerance settings. This helps to prevent tampering by those who are not authorized to set tolerances.

---

## Chapter 6 - Troubleshooting and Service

### PROBLEM

### CAUSE/REMEDY

IMPAX does not turn on.

Not plugged in. Not turned on.

No display or lights.

Check rear panel fuses.

Green light will not come on when button is pushed.

Production quantity not set. Tolerances not set.  
Job totals completed. Light burned out.

Yellow light will not go off although yellow and green have been on together for hundreds of parts. (Learning mode)

Force measurements are erratic. Check force display, check setup.

After yellow and green are on together, yellow goes off but quickly changes to red.

Tolerance is too tight for the job. Job is not steady  
Enough for tolerance selected. Check setup, check forces and tolerance.

IMPAX stops header repeatedly but no problem is found with parts made.

Tolerance is too tight for job. Force measurements  
Are changing. Check tooling, header, material  
Uniformity. Run header; observe forces and parts  
Produced. Check for loose tooling.

IMPAX fails to stop header when problems occur; smashups, breakage, dropped parts. Green light stays on.

Tolerance is set too wide of set to zero. Enter  
lower tolerance number. **Supervisor's Key** is in  
The bypass position.

Green light goes off, "RPM+" or "RPM-" appears on the display.

Running speed of header is changing. Check  
Header, check IMPAX machine position sensors.

Green light is on and header is running, but IMPAX does not count.

Check position sensor, wires, and rear panel fuses.

IMPAX counts parts, but force measurement numbers are zero for one or more channels.

Check force sensors and wires.

---

## SIMPLE REPAIRS

Before performing any service, be sure power is off.

### ***Fuse Replacement:***

Primary circuit protection is provided by a circuit breaker built into the IMPAX power switch; if this trips, merely turn on the switch to reset it. There are two fuses located on the back panel of the IMPAX console. If the power is on but the displays do not light up, check the 3 amp fuse. If the display comes up but the monitor won't count or the force measurements do not come up, check the 1 amp fuse.

To remove a fuse, press the cap in and turn it counter-clockwise. If the fuse appears blown, replace it, but if it appears OK it should still be checked with a meter or test light. Replace only with type 3AG slow-blow fuses of the correct current rating.

There is also a fuse located in the Satellite Box. If the lights on this box do not light, but the IMPAX console is OK, remove the cover of the Satellite Box and inspect the fuse clipped on the board. If bad, replace only with type 3AG slow-blow 1 amp fuse.

### ***Lamp Replacement:***

If a lamp on the Satellite Box will not light, unscrew just the colored lens which covers it. Do not unscrew the ring which surrounds it. Be sure the power to the lamp is turned off, then remove it by pressing the bulb in slightly and turning it one-sixth of a turn counter-clockwise. It will then pull straight out. If it is burned out, replace only with a #1893 or other approved equivalent. Many standard 12 volt bulbs will not be very bright.

### ***Cable Inspection:***

If there is reason to believe that a sensor cable has been damaged, it should be inspected for cuts, abrasions, or undue crushing. Sensor cables may be repaired, but splicing of the damaged section or complete replacement is recommended.

Damaged power cables are a safety hazard and should be repaired immediately according to applicable electrical codes.

Plug and socket connectors should be inspected for damage, strain, or pulled-out wires. Unplug the connection and inspect the mating contacts. Cables and connectors may be checked with a meter or test light; defective assemblies should be spliced or replaced.

### ***Program Memory (EPROM) Replacement:***

To replace the program memory chips with a new program supplied by PTG/IMPAX, follow the steps below. Before beginning, you may wish to display and write down any job or shift totals which the IMPAX memory contains; these may be lost when the program is changed.

First, turn off the IMPAX console and pull the plug for safety. Using a Phillips screwdriver, remove the screw which attach the front panel of the console. Gently tip the front panel outwards. Disconnect the white power supply plug from the front panel circuit board by pressing in the two latches on its sides and pulling it out. Lay the panel down flat on its face; be careful not to stretch or break any of the other connections.

There are three circuit boards fastened to the front panel, the top one must be removed. Disconnect the long gray plug along the side of the board by pressing the levers at each end away from each other; the connector will be lifted up and out. Find and remove the screws holding the board down, being careful not to damage any components on the board nearby.

Find the three sockets containing the program chips. They will have paper labels on top, and be near the middle of the board. There will be a 0, 1, and a 2 chip. Also note that there is a small notch or mark on the end of each chip which is toward one side of the board.

Remove one chip by inserting a small screwdriver or other prying tool under one end, between the chip and the socket, and gently lifting the chip straight out. Try not to bend the pins. Replace it with the new chip bearing the same digit, making sure that the mark at the end faces the same way as the others. Line up the pins on one edge and gently enough to engage the pins on the other side, then when every pin is lined up, press the chip home into the socket. Inspect to be sure no pins are bent.

Repeat the procedure for the other 2 chips.

Replace the top circuit board. Re-insert the gray edge connector and the white power supply connector until they click home. Insert the front panel back into the IMPAX console; being careful that the cables and circuit boards are not pinched against the mounting surface. Replace the front panel screws.

Turn on the unit and follow specified Startup/Initialization Procedures. Reprogram job totals as necessary.

### ***Force Sensor Replacement:***

If the force measurements become erratic, or fall to zero or a very low value, or the cable is cut, the force sensor may need to be replaced. Unfortunately, the force sensor is very difficult to test when installed, and may appear broken when the problem is actually somewhere else. Because some of the force sensor types are usually difficult to replace, test everything else before resorting to sensor replacement.

If the force sensor is to be replaced, disconnect its cable from the Satellite Box and disassemble the machine as necessary. Note how the sensor is installed, then chip out the old sensor and epoxy and clean the recess or mounting surface completely. Follow the instructions supplied with the epoxy adhesive, and be sure to mix it thoroughly. Coat the mounting surface with it,

and install the sensor facing the same way as the old one - the brass plate down, the white part to the top. Press the sensor through the epoxy to the bottom of the pocket. It is very important that the white part, or the Piezoelectric crystal, does not short out to the pocket bottom or sides. Check to make sure that the center wire is not above the surface of the block. Fill the sensor pocket flush or slightly below the surface of the block with epoxy.

You can perform these tests with an ohmmeter - one lead of the meter to the center of the conductor and the other lead to the block.

Reassemble the machine after the adhesive has set, and reconnect the cable.

*Note:* Pre-heating the block or wedge will significantly reduce the curing time of the epoxy.

### ***Position Sensor Replacement or Adjustment:***

If IMPAX will not count parts although the machine is running in green, the problem is related to the position sensor. The simplest problem is that the cam or flag which passes in front of the sensor to actuate it, may be damaged or missing. If this part does pass within 1/4" of the sensor face for the 30mm proximity switch, then the sensor should be adjusted. If the proximity switch is a 12mm one, it needs to be even closer. A voltmeter must be used to make sure that 10 volts is applied to the red and black wires of the sensor, and that the white wire switches when metal is placed in front of the sensor (these wires may be checked on the terminal strip of the circuit board inside the Satellite Box).

If the sensor is bad, it should be replaced. Align and adjust the new sensor and actuator exactly as the old one, or refer to the spacing and timing adjustment steps in "Initial Installation - Position Sensor Installation" at the end of this Section. Even if the sensor is working electrically, it may be wise to double check the timing adjustment.

## **INITIAL INSTALLATION**

Before installing an IMPAX controller system on any manufacturing machine, IMPAX systems may send a Field Service Engineer to evaluate the site, the machine, and any special customer requirements. This includes sensor installation, programming preferences, and coordination with in-plant personnel who may assist in installation.

The following guidelines may help you in preparing for future installations or modifying existing ones. If in doubt, consult the IMPAX service department.

Of course, all mechanical and electrical work should conform to industry standards and applicable safety codes.

***General Guidelines - Electrical:***

Both low voltage (Class II) and high voltage (110v, Class I) are employed in each installation. They should not be mixed within any conduit or enclosure unless properly partitioned apart. All wiring should be conducted within suitable conduit and enclosures, and such should be oil proof wherever oil is present. Wiring may be run inside or outside the machine, considering safety, serviceability, appearance and convenience when deciding. In some cases, existing machine wireways may be used (shared).

110 volt power for the IMPAX console should not be derived from the machine power, but should be an isolated circuit known to be free of electrical interference, surges, and drops due to motor loads.

The interconnection cables between the IMPAX console and the machine need not be encased in conduit, but doing so may be desirable to enhance physical protection and appearance.

Termination and attachment of cables may be done by IMPAX service engineers at the time of installation.

***General Guidelines - Mechanical:***

Because each machine and plant is different, mechanical attachment and arrangement of some components may vary. Adaptation of these parts may require some ingenuity and fabrication. If no reasonable solution to a problem can be found, the IMPAX installers can offer advice or assistance. All work should be neat, solidly attached (shake proof), and should not interfere with operation, maintenance, or repair practices.

***Console Location:***

The IMPAX console should be mounted near the machine it controls; ideally, visible from the operating station. It is usually not advisable to attach it directly to a manufacturing machine, or on any other place subject to sever vibration or heat. It may be hung from above, fastened to a wall, pillar, shelf, or mounted on a pedestal. It should be convenient to reach, but not in a place where it will obstruct traffic or be subject to damage. An isolated power line must be available nearby.

***Satellite Box location:***

The small Satellite Box must be mounted on the manufacturing machine. It contains an electronic board and serves as a junction point for all IMPAX wiring on the machine. Three Status Lights may be mounted on this box, or in another place. The lights should be visible from all directions. The IMPAX Reset Button is incorporated into the red light. On small machines, the lights can be mounted on the box, in one location which meets all of these requirements.

***Console to Satellite Box Cable:***

A low-voltage, multi conductor cable must connect the Satellite Box to the IMPAX console. This cable need not be encased in conduit.

***Connection to Machine Electrical Cabinet:***

In order to stop the machine, several wires must be run from the Satellite Box to the machine electrical cabinet or control panel. These wires must be inside a conduit.

***Sensor Connections:***

Wires from the Position and Force sensors must be returned to the Satellite Box. Although it is not strictly necessary that they be inside conduits, it is advisable to do so for the physical protection of the delicate wires. Wiring should be spliced in such a way that troubleshooting or replacement of sensors is not excessively difficult.

***Installation of Force Sensors:***

The sensor disk with attached wire is typically installed in a recess on a stressed location in the forming machine, such as a die backing plate, punch wedge, ram, rocker, or other plate depending on what force is to be measured. Consult Process Technologies Group if in doubt about the best location. Once the location is chosen, cut the recess by milling, grinding or EDM, as necessary. The dimensions of the milled pocket are available upon request from our Technical Service Department. The groove for the wire should be cut so that the wire is safely conducted away from the area into a conduit or under a cover; this is to protect it from damage. Install the disk using the epoxy adhesive provided. The glue should be mixed thoroughly. Apply a coating of adhesive to the recess, then press the sensor disk into place with the brass side of the disk against the piece. The epoxy should set up in 1 to 2 hours. For best results allow the epoxy to set overnight before running machine.

***Installation of Position Sensors:***

The Position Sensor, a proximity switch, is a non-contacting switch which is used to provide timing information. Each time the machine makes a part, or strikes a blow, or reaches a certain phase of its cycle, a position sensor can be adjusted to turn on or off to indicate it. Typically, one sensor is used to count parts made (on and off once each time) and time the forming stroke (on during the forming blow). Another sensor may be used on single and double die machines to increase sensitivity. Observe the machine cycle to find a rotating or reciprocating member which can be used to actuate the sensor. Attach a flag, cam, or sensor strip to the moving part and position the sensor switch using appropriate brackets. The metal must move to within 1/4" of the sensor for the 30mm prox. Switch to be "on", and even closer for the 12mm prox. Switch. When the flag or cam leaves that small space the switch will turn off until it passes close again. Turn the machine through a full cycle to be sure that nothing touches or interferes. Verify that the sensor is switched on and off at the intended times. It is important to note that on each machine cycle of a single die, two blow header, two (2) blows occur. The proximity switch must be timed off of the half speed shaft.



## CUSTOMER SERVICE

**If you have a problem which cannot be fixed by any of the procedures in this book, do not hesitate to call IMPAX for service. Often, the problem can be fixed by simple instructions over the telephone. Before calling, be sure you know all of the facts and symptoms of the problem, information about the model and program revision numbers of the IMPAX unit, and the make and the model of the header, roller, or other machine which it controls. This makes it possible to quickly pinpoint and solve the problem.**

**Before calling, you should know:**

**IMPAX Serial number (on side of console):** \_\_\_-\_\_\_-\_\_\_

**Software Version:**           **Version**\_\_\_\_\_ (should be in the form of XXXXX-XX)

**Definition Package**       **P**\_\_**TH**\_\_**D**\_\_

**\*Note: Refer to Chapter 8 of the Supervisor's Guide for instructions on accessing the IMPAX software version and definition package.**

**Machine Make:**\_\_\_\_\_

**Machine Model:**\_\_\_\_\_

**Number of Stations:**\_\_\_\_\_

## Chapter 7 - Programming for the IMPAX 1000

### *Introduction*

The IMPAX process monitor is pre-programmed to monitor one of several ‘generic’ types of machines; the number of channels, timing, etc., are all present. This is called the Default Pack, because it determines the standard method of operation. When the unit is installed, it is ‘customized’ to operate exactly as required for the particular machine it is monitoring. If you wish to change the program to solve some special problem, you must follow the directions below.

For each IMPAX unit, there is a “Custom Programming” sheet, which shows how the IMPAX unit was configured at the time of installation. Note any changes you make to the program on this sheet for future references; if the IMPAX memory is cleared for any reason the Default Pack is automatically reloaded, and you would need to reprogram the unit to ‘remind’ it how you want it to work.

Do not try to change the unit’s Program Definition while the unit is monitoring a forming job--the process of changing the Program Definition would make continued proper control impossible. If you must continue to run the machine while changing the Program Definition, place the IMPAX/BYPASS keyswitch on the Satellite Box in the BYPASS position.

Begin by making sure the IMPAX is in the Stop (Red) mode. If it is not turn the rear-panel power switch off, then back on.

Each unit is shipped from the factory with the access code set to 5686; however, you may change this number to protect the security of the Program Definition. This is discussed later in this chapter.

Definition of the unit’s program is split into two areas: Machine/Relay definition and Channel Definition. Channel Definition tells the IMPAX how to monitor each input; you may need to change this program occasionally as your jobs and/or your needs change. Machine/Relay Definition tells the IMPAX how to control the machine and accessories. Once this is properly set up at the time of installation, it should very rarely need to be changed.

## SYSTEM/FAULT PROCEDURES

Whenever the power to the IMPAX CPU is interrupted, you will see a display "SYSTEM FAULT". This can happen whenever there is a power surge or if the IMPAX unit is taken apart and the front panel is disconnected from the power supply.

If you know in advance that this is going to happen, it is recommended that the counts be recorded so that they can be re-entered.

The sequence for recovery is as follows:

SYSTEM FAULT/CALL SUPERVISOR	- ENTER
ACCESS	X, X, X, X - ENTER
CALL PTG	ENTER
CLEAR MEMORY?	ENTER
ENTER COUNTS?	If counts are known - ENTER
OLD TOTAL	XXXXXXXXX - ENTER
OLD PARTS MADE	XXXXXXXXX - ENTER
OLD SHIFT COUNT	XXXXXXXXX - ENTER
OLD BREAK	XXXXXXXXX - ENTER
OLD BREAK MADE	XXXXXXXXX - ENTER
ENTER COUNTS?	If counts are not known - ENTER

## BASIC INFORMATION/ FUNCTION #'s

You must understand the operation of the Function (#) Key before any programming can be done. This key is used in combination with a numeric key to move to the appropriate selection. Those selections are:

Function #3 will send you to the Channel Definition. This area will allow you to define how the IMPAX will process the information from each sensor. For more information see the            section on Channel Definition.

Function #4 will send you to the Diagnostics. Please refer to Chapter 8 on Diagnostics for more information.

Function #5 will send you to Relay Definition. In Version 58 Software, there is much more than relays defined in this section. This section is actually the definition of how the IMPAX interacts with the machine. See the section on Relay Definition for more details.

Function #0, #1, #2, #6, #7, #8, and #9 have no meaning.

## CHANNEL DEFINITION (FUNCTION #3)

To begin Channel Definition, press # and then 3; the display will show “ACCESS”, which tells you that you must enter the four-digit access code for this unit before you will be allowed to see and/or modify the Channel Definition. Press the numbers of your access code; the display shows a “\*” for each digit pressed. After you have pressed the four digits, press Enter/Yes.

If the number you have entered does not match the IMPAX unit’s access code, the display will show “ACCESS DENIED” for a few seconds, followed by a production counter. If the display shows “LOAD STD PGM?”, you have entered the correct access code, and you may now check and/or modify the unit’s Channel Definition. If you press Enter/Yes, the Default Pack Channel Definition will be loaded for you to use as a starting point in customization. Use caution however, because loading the Standard Program permanently erases custom changes that were previously set into the IMPAX, and may be difficult to reconstruct. If you press Next/No, the following steps will show you how the unit is currently programmed.

The display will now say “1 CHAN DEFINE?”. If you wish to define Channel 1, press Enter/Yes; to operate on a different channel, press Back/Review or Next/No until that number is displayed, then press Enter/Yes. There are sixteen channels, numbered 1 through 9 and A through G.

When you have pressed Enter/Yes to select a channel, IMPAX will display “CHAN ENABLED” or “CHAN DISABLED”. Press Next/No if you wish to change this, then press enter. If you disable the channel, it will simply not exist in the operation. The channel definition program will go on to the next channel number automatically.

If the channel is enabled, you must set up all of its operating parameters. The display will first say “FORCE LINE - ”, asking which force sensor is to be assigned to the Channel. There may be as many as 8 force sensors installed in the machine but only 1 can be selected for each channel. Press the number of the sensor you wish to select and the press Enter/Yes.

The next display is “INTEGRATE” or “PEAK”; this pertains to how the force measurement is interpreted. When you select INTEGRATE, IMPAX will consider many observations during each forming stroke. By considering all of the readings it establishes a number which represents the total area under the curve. When you select PEAK, IMPAX will consider many observations but will establish the number which represents the highest value in all of the readings. PEAK or INTEGRATE may be selected by pressing Next/No, but should not be changed without good reason. Press Enter/Yes to lock in your choice.

PTG/IMPAX recommends that INTEGRATE be used unless there are unusual circumstances such as a very erratic reading from a sensor.

The next display is “P TARGET - ”, with a number from 0 through 255. This is the force reading the unit will try to calibrate its internal peak detection circuitry to during the automatic adjustment cycle. Enter a three-digit number from 0 to 255, then press Enter/Yes. PTG/IMPAX recommends that this value be set to 96.

This display will now show “I TARGET - “ with a number from 0 through 255. This is similar to the function above, except that it deals with the calibrated value for the integrated reading. The normal setting for this target is 128. Enter a three-digit number from 0 to 255, then press Enter/Yes.

Next, the position sensor must be defined. The display will say “POSITION SENSE”; press Enter/Yes. It will then say “PROX SW. LINE - 1 ”, asking which position sensor is to be assigned to this channel. There may be as many as 2 position sensors installed; press the number of the sensor you wish to select and the press Enter/Yes. The next display will either be “READ WHILE ON” or “READ WHILE OFF”; this determines whether the force sensor is ‘looked at’ while the chosen position sensor is on or off its metal cam or flag. Press Next/No if you wish to change the selection, then press Enter/Yes.

The display will now show “BACKSTROKE ON” or “BACKSTROKE OFF”. This determines whether or not this channel is monitoring a threadroller or threadroll-like station. “BACKSTROKE ON” enables several features intended for use in a threadroller monitoring application. Press Next/No to select between the two choices, then press Enter/Yes to lock it in. If you select “BACKSTROKE OFF”, the next three paragraphs are not applicable.

If you selected “BACKSTROKE ON”, the display now shows “BKST H LIM ON” or “BKST H LIM OFF”. BKST stands for Backstroke, the return stroke of the movable die on a flat-die threadroller. BKST H LIM, when enabled, helps the IMPAX unit interact with a threadroller by allowing the IMPAX to detect a part stuck to the die during the backstroke. Such a condition, if not caught by IMPAX, could damage the tooling. Press Next/No to select between the two choices, then press Enter/Yes to lock it in. If you select “BKST H LIM OFF”, the next two paragraphs are not applicable.

If you selected “BKST H LIM ON”, the display will now show “BKST EXC ON” or “BKST EXC OFF”. This determines whether the IMPAX unit will allow you to program exceptions for the backstroke limits. Backstroke exceptions are rarely ever allowed but can be when there are problems with a threadroller which causes nuisance shutdowns in the backstroke cycle, if all other causes for backstroke noise have been eliminated. Press Next/No to select one choice or the other, then press Enter/Yes.

The display will now show “NOFEED ON” or “NOFEED OFF”. This determines whether or not you will be allowed to program in an ‘allowable’ number of nofeeds. Press Next/No to select one choice or the other, then press Enter/Yes.

The next step will choose whether the low or high force limits are disabled in the force tolerance settings. The display shows which are *enabled*. The three possibilities include: “LO + HI LIMITS”, “LO LIMIT ONLY”, or “HI LIMIT ONLY”. Press Next/No to change it and then press Enter/Yes when you have found your choice.

The next display shows “LIMITS ON SLMH”. The SLMH indicates which of the limit tests are activated for this channel. The IMPAX monitor performs four limit tests for every blow by retaining in memory the learned force limits from the previous stroke. It then compares that value in memory to the value of the current stroke and that is called the “Single Hit Limit.” The IMPAX monitor can also compare the learned value of the last four (4) strokes and that limit is called the “Low Count Limit”. The IMPAX monitor can further compare the learned value to the average value of the last sixteen (16) strokes and that is called the “Medium Count Limit”. Lastly, the IMPAX monitor can compare the learned value to the average value of the last sixty-four (64) strokes and that is called the “High Count Limit”. It is possible to disable the limits for this channel by blanking out the letters SLMH. The display shows which limits are enabled, for example “LIMITS ON S ” would mean that only the Single Hit Limit is operating. PTG/IMPAX recommends that all four tests remain active. The Single Hit Test is the critical test but the others are valuable in detecting tool wear. To turn them on or off, press:

- 0 for Single Hit Limit
- 1 for Low Count Limit
- 2 for Medium Count Limit
- 3 for High Count Limit

Press Enter/Yes to lock in your selection once it is made.

The display now shows “FIXED ENABLED” or “FIXED DISABLED”. This feature disables the automatic tuning built into IMPAX and allows the operator to establish their own upper and lower limits. This feature is typically used if you want the limits wider than those supplied with a tolerance setting of 9 or narrower than those supplied with a tolerance setting of 1.

PTG/IMPAX recommends FIXED DISABLED except under special circumstances. Press Next/No to select one choice or the other, then press Enter/Yes.

The next display is “FAST LIMITS OFF” or “FAST LIMITS ON”. FAST limits ‘LEARNS’ just like a normal LEARN cycle, it just does it a lot faster. This is useful if you need faster protection than a normal ‘LEARN’ cycle will give you.

The next display is “TREND LIM OFF” or “TREND LIM ON”. The trending function ‘off’ lets the force limits move with long-term changes or trends in the force measurements; this reduces the chance of detecting long-term trends such as tool wear, but eliminates false shutdowns due to these changes. Trending ‘on’ puts a programmable limit on such changes. Press Next/No to select your choice, then press Enter/Yes.

The next step concerns error exceptions. An exception count permits a certain number of parts (up to 99%, as selected in the tolerance conversation) to be let-by; these may be above the upper limit, below the lower limit, or both. For instance, low exceptions would be useful for passing dropped blanks in certain heading operations. If you select “EXCEPTIONS OFF”, this feature is turned off. Selecting “LO EXC ONLY”, “HI EXC ONLY” or “LO + HI EXCS” will determine which limits are affected. The percentage will be determined in the tolerance setting for each channel. Make your choice by pressing Next/No, then lock it in by pressing Enter/Yes.

Finally, the name of the channel can be set. A selection of names is as follows:

CHANNEL	STATION	PUNCH
WEDGE	BLOW	DIE
CUTOFF	HEAD	EXTRUDE
ROLL	BACKSTR	KICKOUT

A number can be placed after any name by pressing the number buttons and then pressing the number buttons. A number can be erased by pressing \*. You can step through the list of names by pressing Next/No. When a suitable name is displayed, press Enter/Yes.

That completes one channel definition. The next prompt will ask if you wish to define the next channel. Repeat the above procedure as many times as necessary to complete the entire definition for the machine.

If you make a mistake, it is often possible to use the Back button to return to the mistaken entry and correct it. At worst, you can repeat the steps for One Channel to correct it.

## MACHINE/RELAY DEFINITION (FUNCTION #5)

To begin Machine/Relay Definition press # and the number 5; the display will show “ACCESS”, which tells you that you must enter the four-digit access code for this unit before you will be allowed to see and/or modify the Relay Definition. Press the number of your access code; the display will show a “\*” for each digit pressed so others cannot see you access code. After you have pressed the four digits, press Enter/Yes.

If the number you have entered does not match the unit’s access code, the display shows “ACCESS DENIED” for a few seconds, then the unit clears itself and the display shows a counter.

If the display shows “LOAD STD PGM?” you have entered the correct access code, and you may now check and/or modify the Machine Definition.

If you press Enter/Yes, the Default Program will be loaded for you to use as a starting point. Use caution however, because loading the Standard Program permanently erases custom changes that were previously set into the IMPAX, and may be difficult to re-construct. If you press Next/No, the program which has been running will be displayed (this may or may not be the Default Program). In either case, you may change these values by using the following steps. The first display will read “SET AMP LIMITS?”

### *Setting the Amp Limits*

This step allows the user to set the amplification limits and the integrate limits, which enables the IMPAX to alert the operator of an inoperative sensor. These values are set with the Machine and the IMPAX unit operating. The IMPAX will give a certain three digit number (XXX) when running, and a higher number when the sensor is unplugged (from the satellite box) or not working. If you set the limit above where the machine is running at, and the sensor goes bad, then the AMP reading will go over the limit and will cause a MAX AMP error. If you don’t want to set AMP LIMITS, press the Next/No key. If you do want to see them, or set them, press Enter/Yes and the display will show “XXX MAX AMP - 0”. The XXX is the highest AMP value since the last LEARN cycle. The 0 is the limit, and can be set anywhere from 0 to 254. The MAX AMP is the Peak value. You do not have to set this, but if you do, it must be above the number on the left for that job or you will keep getting errors.



Press Enter/Yes again and the display will show “XXX MAX INT - 0”. This is the integrated value, and the numbers have the same meanings as the previous display. This can also be set from 0 to 254. If a number is entered it must be between 0 and 254 and it will generally be closer to the higher number. Both steps are set by the same procedure. To pass to the next step without setting these values, press the Next/No key.

### ***Setting the RPM Stop***

The display will read “RPM SENSE ON” or “RPM SENSE OFF”. This determines whether or not the IMPAX unit will stop monitoring the machine if it detects a change in machine speed. In almost all cases, the correct choice here is “RPM SENSE ON”. The only exception to this rule is the application where the machine normally stops at some irregular interval without operator intervention. Press Next/No to select the correct choice, then press Enter/Yes.

### ***Setting the Count Channel***

The display will read “COUNT LINE” which is asking you to define which position Sensor Channel (1 through 2, if equipped) is to be used to trip the IMPAX parts counter. This position sensor should give one pulse each time the forming machine makes a part or goes through a cycle. Press the desired number, then press Enter/Yes.

### ***Programming the IMPAX Relays***

The display will read “1 RELAY DEFINE?”, which is asking you if you want to check and/or modify the operating program for relay 1. If you wish to define relay 1, press Enter/Yes. To go on to a different relay, press Back/Review or Next/No until the desired relay number is displayed, then press Enter/Yes. There are four relays, which can be programmed independently.

If you pressed the Enter/Yes key, you are ready to program a Relay and the display will show “DEFAULT OFF”. OFF means that the circuit is open during normal operation, ON means that the circuit is closed during normal operation. The Next/No key allows you to toggle between these two entries. Once you have pressed Enter/Yes, you will see the display “MODE CHNG RELAY.” You can press Next/No at this screen to toggle between four different options. These options are:

1. ***The Mode Change Relay*** will activate whenever the IMPAX changes to the designated mode. The typical setting is Stop. This means that whenever IMPAX goes into STOP mode (red light), it will activate the relay.

2. **The Break Relay** is associated with the Break Counter in the Quantity Display. Whenever this relay is defined it will activate whenever IMPAX reaches the Break Quantity.
3. **The Exception Relay** is associated with Exceptions as they are defined in the Channel Definition. This is typically used for attaching the relay to an air solenoid so that a gate can be shut or a diverter can be activated when an error is detected but you do not want to shut down the machine.
4. **Relay Disabled** means that you do not want to use this particular relay for this application. Once you have selected the type of relay you want this relay to be, press the Enter/Yes key.

If you selected MODE CHNG RELAY, the next display will show “RELAY ON ????” The question marks can be a combination of the letters STPL. This indicates the modes for which the relay will be activated. (S - Stop, T - Test, P - Production, and L - Learn, respectively) You can set any combination of these by pressing the keys 0, 1, 2, and 3 which stand for the letters S, T, P, and L respectively. Any letter which is displayed specifies a mode for which the relay will be activated. When the display shows the correct combination, press Enter/Yes.

The display will show “IMMEDIATE STOP” or “CYCLED STOP”, which indicates whether or not the timing of the selected relay will be synchronized to a specific point in the machine’s cycle. For advice on relay use, you may want to contact PTG/IMPAX Service. Press Next to alternate between the two choices, the press Enter/Yes to lock it in.

If you entered “IMMEDIATE STOP”, the definition of this relay is complete and the display will show “2 RELAY DEFINE”; otherwise, the display will now show “NO. OF CYCLES”, followed by a number from 0 to 9. This specifies the number of machine cycles to delay the activation or de-activation of the relay. Press a number from 0 to 9, then press Enter/Yes.

The display will now show “PROX SW. LINE - 1”. This indicates which position sensor will be used to count the number of cycles for the delay. Press 1 or 2, then press Enter/Yes. In older units, this display will be replaced by “SENSE LINE - 1”. These both mean the same thing. The display will now show “TRIP WHILE ON” or “TRIP WHILE OFF”. This determines which state the position sensor is in when the relay is activated or de-activated, and is most important when trying to synchronize the machine’s brake to prevent top-stops. Press Next/No to toggle between the two choices, then press Enter/Yes to select your choice. In older monitors this display will be replaced by “READ WHILE ON” or “READ WHILE OFF”. These displays mean the same thing.

The display will now show “TIME VALUE - 0”. This is a delay in addition to any cycle delay specified, and is entered in .1 second units. Enter a number from 0 to 99 (for 9.9 seconds) then press Enter/Yes. That completes the definition of one relay. If you have not yet had the opportunity to check and/or modify the definition of all the IMPAX unit’s relays, the display will ask if you want to define the next one. If you have completed all steps of Machine Definition, the display will show “RELAY SET DONE” for a few seconds, followed by the default counter.



the left and right sides of the screen that are changing rapidly, there is data being transmitted or received by the IMPAX via the IMPAXNET.

### ***Software Version and Definition Package ID:***

Press the number 1 key. The display will show “VERSION XXXXX-XX”, the X's reference the software version that is in the IMPAX system.

Press Enter/Yes. The display shows “P-X TH-YY D-ZZ”.

**X** refers to the software language in the IMPAX:

- 0** is English
- 1** is German
- 2** is Spanish
- 3** is French
- 4** is Portuguese
- 5** is Italian

**YY** refers to the tolerance threshold table:

- 00** indicates Standard Limits
- 01** indicates Tight Limits
- 02** indicates Tighter Limits

**ZZ** refers to the definition package:

- 00** is for 1 Die 2 Blow
- 01** is for 2 Die 3 Blow or 2D4B
- 02** has 2 force line capability
- 03** has 3 force line capability
- 04** has 4 force line capability
- 05** has 5 force line capability
- 06** has 6 force line capability
- 07** has 7 force line capability
- 08** has 8 force line capability
- 09** is for Roller
- 10** is for 1D2B with shortfeed sensor
- 11** is for 2D3B or 2D4B with shortfeed sensor
- 12** has shortfeed plus 2 force line capability
- 13** has shortfeed plus 3 force line capability
- 14** has shortfeed plus 4 force line capability
- 15** has shortfeed plus 5 force line capability
- 16** has shortfeed plus 6 force line capability
- 17** has shortfeed plus 7 force line capability

Press Enter/Yes. The IMPAX is now back to the “DIAGNOSTICS” display.

### ***Checksum and Memory Test:***

Press the number 3 key. The display shows “BYPASS IMPAX?”.

Press the Enter/Yes key. (Note: When the IMPAX is bypassed there is **no machine protection.**) The display will show two or three four digit characters, these four digit characters are the checksums of the software loaded into EPROMS on the CPU board.

Press Enter/Yes. The display shows “BLOCK 0 GOOD”. This is a self test that checks the blocks of RAM on the CPU board.

Keep pressing Enter/Yes to check all the blocks of memory. When all the memory is tested the IMPAX will go back to the “DIAGNOSTICS” display.

If you choose not to bypass the IMPAX by pressing Next/No at the “BYPASS IMPAX?” prompt, the IMPAX will go back to the “DIAGNOSTICS” display.

### ***Light, Relay, and Display Test:***

Press the number 4 key. The display shows “BYPASS IMPAX?”.

Press the Enter/Yes key. The display now shows “5-GRN 6-YL 7-RED”.

Pressing the number 1, 2, 3, or 4 key will activate relays 1, 2, 3, or 4 respectively. Pressing the number 5, 6, or 7 key will activate the green, yellow, or red lights respectively. (Note each time a number is pressed the previous relay or light is turned off.)

Press Enter/Yes. The display shows “ \* ”.

Press Next/No to step through the first part of the display test, the asterisk will shift through each segment of the display each time the Next/No key is pressed. When each segment has been tested a “O” will appear in the first segment of the display, pressing Next/No will again shift the “O” through each segment.

Press Enter/Yes to step to the next display test. The screen will now show a variety of characters. Continue to press Next/No, a variety of symbols, numbers, and letters will scroll across the screen. To end this test press Enter/Yes. The display now shows “DIPS- 00 or DIPS- 00000000”.

Press Enter/Yes. The IMPAX is now back to the “DIAGNOSTICS” display.

## *Signal Strength and Amplification Values*

Press the number 8 key. The display shows “BYPASS IMPAX?”.

Press the Enter/Yes key. (Note: When the IMPAX is bypassed there is **no machine protection**.)  
The display shows “C1 XXPYY XXIZZ”.

**C1** is the current channel, blow, station.... that you are looking at.

**XXPYY** - The **P** in this set of characters means you are looking at the Peak values.

**XXIZZ** - The **I** in this set of characters means you are looking at the Integrate values.

**XX** is the current amplification value for the corresponding channel. **FF** is the maximum and **00** is the minimum amplification value for any channel. If you get a **FF** or **FE** reading on any channel there is not enough sensor signal for that channel to properly tune into the Peak or Integrate target. If you get a **00** or **01** reading on any channel there is too much sensor signal for that channel to properly tune into the Peak or Integrate target.

**YY** is the current input signal value converted into hexadecimal format, this value should be very close to the hexadecimal equivalent of the Peak target. The hexadecimal equivalent to the standard Peak target of 96 is 60.

**ZZ** is the current input signal value converted into hexadecimal format, this value should be very close to the hexadecimal equivalent of the Integrate target. The hexadecimal equivalent to the standard Integrate target of 128 is 80.

Press the Next/No key one time for each channel you wish to look at. If you keep pressing Next/No the IMPAX will keep stepping through each channel, when you reach the last channel the IMPAX will go back to the first channel and start over.

If you think the channel you are looking at has an invalid amplification value, you can press the 0 key to retune that channel.

You can press the Enter/Yes key at any time to get back to the “DIAGNOSTICS” screen.

## Chapter 7 - Specifications and Drawings

### *SPECIFICATIONS*

Controller type: Microprocessor-controlled monitoring and control system for forming machines.

Measuring System: Force and pressure sensing by piezoelectric transducers; typical size 1-1/8 inch diameter by 1/8 inch thick, or less. Output range: .4 to 200 volts. Interpreted by 8-bit analog-to-digital converter.

Timing System: Parts counting and measurement timing by non-contact metal detecting switches on cams or other machine parts. 10-volt output pulse.

Operator Controls and displays: At machine: "RESET" button and red status light.  
At console: Alphanumeric display for measurement and messages, push-button controls, and Supervisor Keylock to protect settings.

Machine Control: Four relays, operating independently. Immediate, timed, or cycled delay. Each rated 8 amps, 250 volts AC maximum. May be used to stop machine, feed, output diverter, or other accessories.

Power Requirements: 115 volts at 1 amp or 230 volts at 1/2 amp, 50/60 Hz AC. IMPAX is protected against surges and motor interference.

Dimensions: Satellite Box: 8" H x 6" W x 4" D  
Control Console: 11-3/4" H x 10-3/4" W x 9" D  
Satellite Cable: multi conductor, oil resistant covering, 10 foot length  
Console weight: Approx. 30 lbs  
Distance from IMPAX to machine: Recommended maximum of 20 feet

Environmental Protection: Satellite Box and fittings are sealed to NEMA 13. Resistant to oil, heat, and vibration.

Control Console: Keyboard and case are resistant to oil, smooth and easy to clean. Withstand extremes of temperature and humidity. Resistant to static electrical discharge.

Battery: Ni Cad - rated for 6-8 year life.



**DRAWINGS**

# Backview of the Control Console

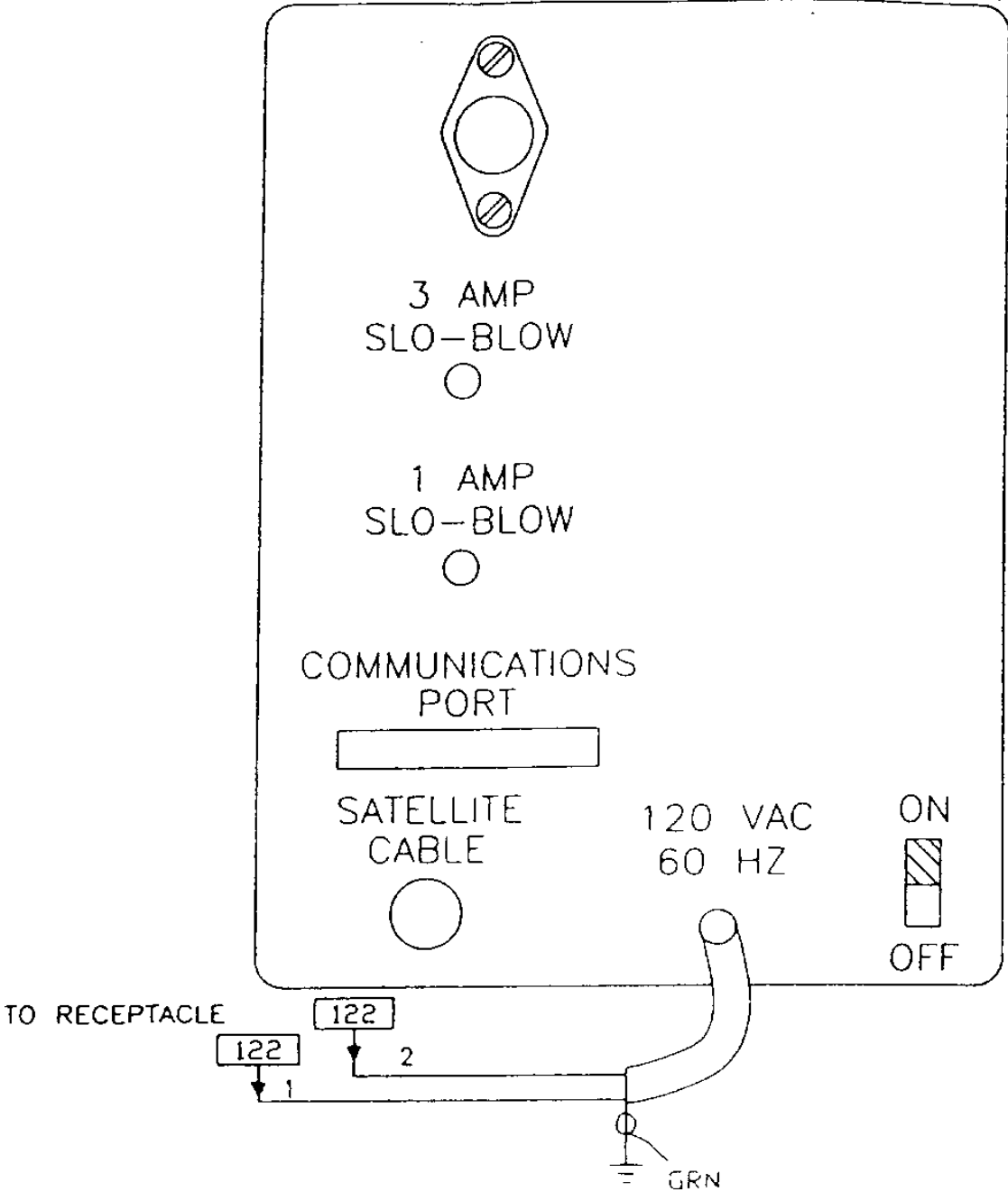

# Satellite Box Circuitry

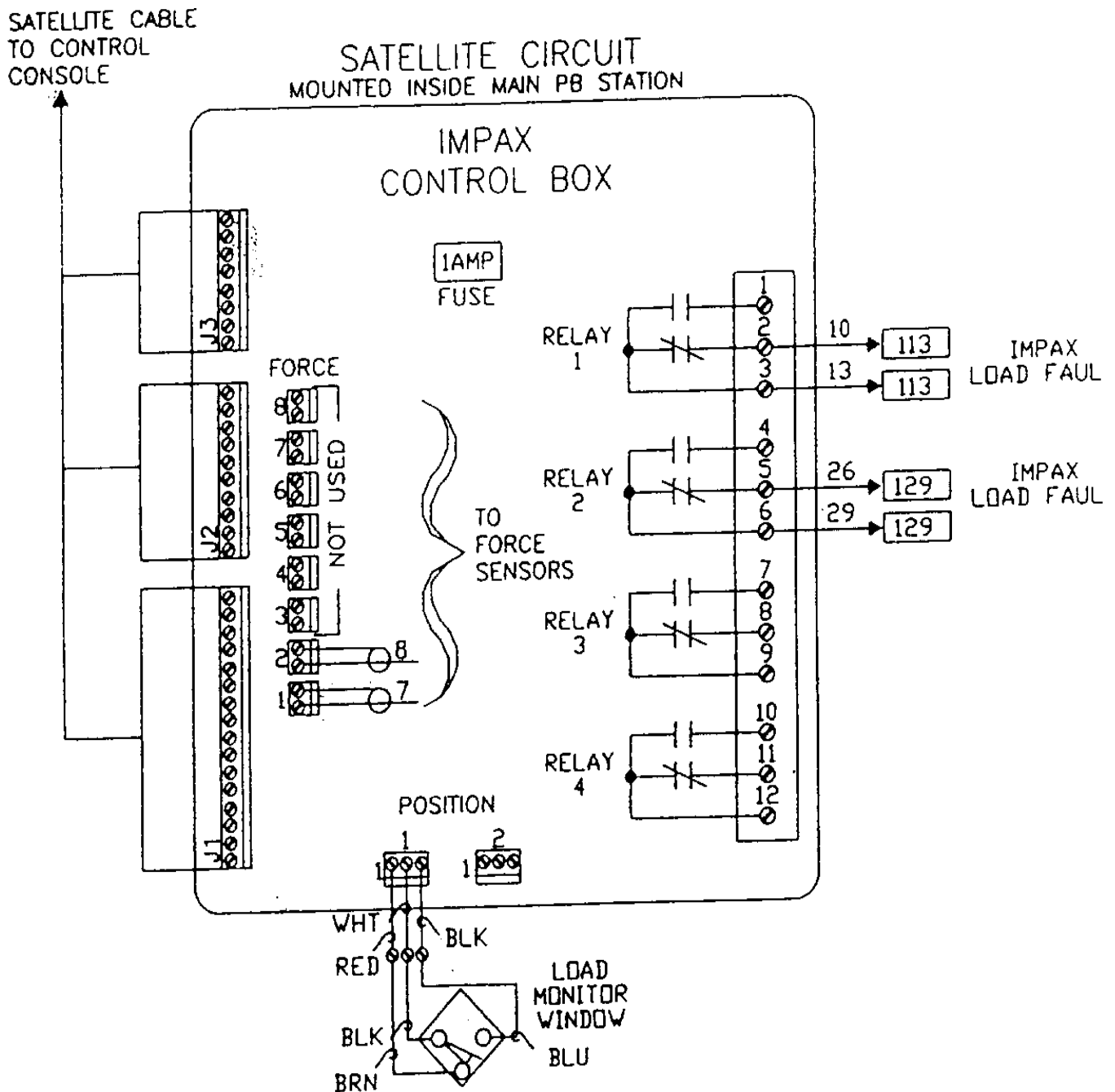

# IMPAX 1000 Control Console

